





































































## PRODUCT REGISTRATION CARD

- All fields are required, or warranty registration is invalid and void

Your Company Name \_\_\_\_\_

Contact \_\_\_\_\_

Address Line 1 \_\_\_\_\_

Address Line 2 \_\_\_\_\_

City \_\_\_\_\_

State/Province \_\_\_\_\_ ZIP/Postal Code \_\_\_\_\_

Country \_\_\_\_\_

E-mail \_\_\_\_\_ Phone \_\_\_\_\_ Fax \_\_\_\_\_

Which DEVA Broadcast Ltd. product did you purchase? \_\_\_\_\_

\_\_\_\_\_  
\_\_\_\_\_

Product Serial # \_\_\_\_\_

Purchase date \_\_\_\_ / \_\_\_\_ / \_\_\_\_

Installation date \_\_\_\_ / \_\_\_\_ / \_\_\_\_

\_\_\_\_\_  
Your signature\*

\*Signing this warranty registration form you are stating that all the information provided to DEVA Broadcast Ltd. are truth and correct. DEVA Broadcast Ltd. declines any responsibility for the provided information that could result in an immediate loss of warranty for the above specified product(s).

**Privacy statement: DEVA Broadcast Ltd. will not share the personal information you provide on this card with any other parties.**



## Appendix A

### LIST OF DB8000 FACTORY DEFAULT SETTINGS

---

FTP Data Port	2020
FTP Command Port	2021
FTP User Name	admin
FTP Password	deva
IP Address	192.168.1.2
Gateway	192.168.1.1
Subnet Mask	255.255.255.0
WAN Address	192.168.1.2
AUX Level	0 dB
MP3 Level	0 dB
Source Priority	MP3
Player Mode	List
Bass Frequency	130 Hz
Bass Level	0 dB
Treble Frequency	5 kHz
AUX Start Code	not assigned
AUX Stop Code	not assigned
MP3 Start Code	not assigned
MP3 Stop Code	not assigned
Threshold Level	-25 dB
Action Delay	5 sec
Release Delay	5 sec
E-mail Alarm Alert	enabled
E-mail Login	db8000@devabroadcast.com
E-mail Password	db8000
SMTP Server	mail.host.bg
SMTP Port	25
SSL	disabled
E-mail Recipient	db8000@devabroadcast.com
Device ID	DB8000
SNMP Agent	disabled
SNMP Traps	disabled
Agent Community	DEVA8000
Traps Community	DEVA8000
Agent Port	161
Traps Port	162
Traps IP	192.168.1.1

## Appendix B

### LIST OF DB8000 JUMPER SETTINGS

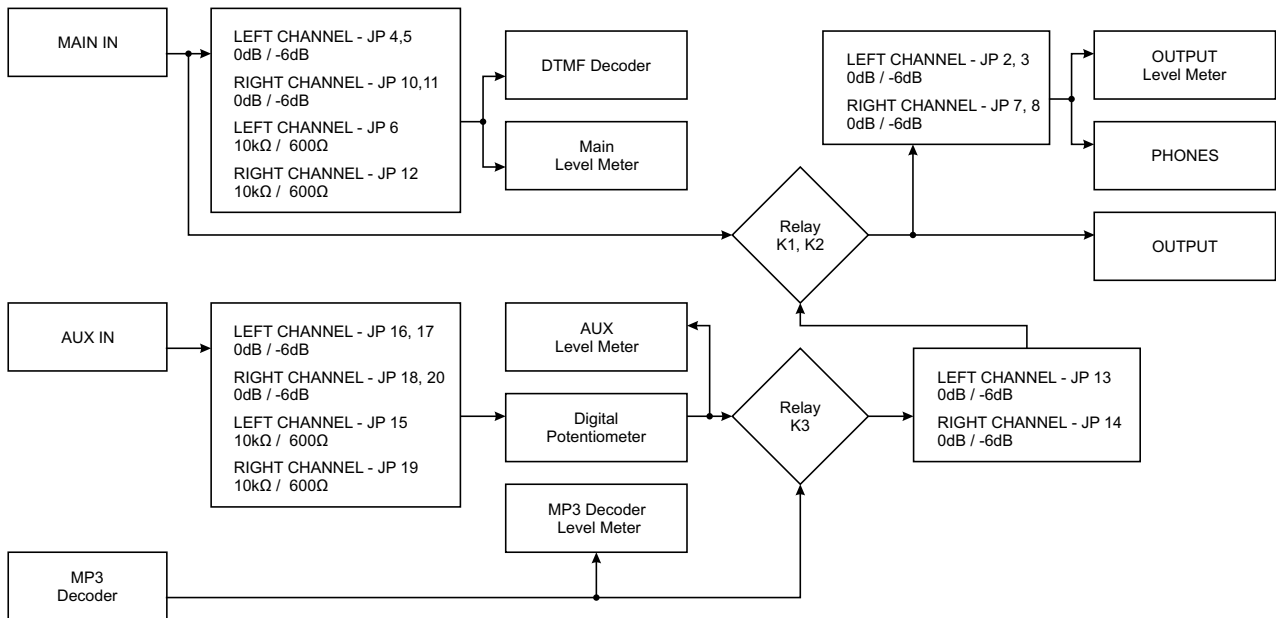

Input Gain = 0 dB

MAIN INPUT	LEFT	Channel	Jumper	Position
			JP4	1-2
			JP5	1-2
			JP2	1-2
	RIGHT		JP10	1-2
			JP11	1-2
			JP8	1-2
			JP7	1-2

Input Gain = -6 dB

MAIN INPUT	LEFT	Channel	Jumper	Position
			JP4	2-3
			JP5	2-3
			JP2	2-3
	RIGHT		JP10	2-3
			JP11	2-3
			JP8	2-3
			JP7	2-3

Input Gain = 0 dB

AUX INPUT	LEFT	Channel	Jumper	Position
			JP17	1-2
			JP16	1-2
			JP13	1-2
	RIGHT		JP2	1-2
			JP3	1-2
			JP18	1-2
			JP20	1-2
	JP14	1-2		
	JP8	1-2		
	JP7	1-2		

Input Gain = -6 dB

AUX INPUT	LEFT	Channel	Jumper	Position
			JP17	2-3
			JP16	2-3
			JP13	2-3
	RIGHT		JP2	2-3
			JP3	2-3
			JP18	2-3
			JP20	2-3
	JP14	2-3		
	JP8	2-3		
	JP7	2-3		

Input Impedance = 600Ω

MAIN INPUT	Channel	Jumper	Position
	LEFT	JP6	2-3
	RIGHT	JP12	2-3

Input Impedance = 10kΩ

MAIN INPUT	Channel	Jumper	Position
	LEFT	JP6	1-2
	RIGHT	JP12	1-2

Input Impedance = 600Ω



AUX INPUT	Channel	Jumper	Position
	LEFT	JP15	2-3
	RIGHT	JP19	2-3

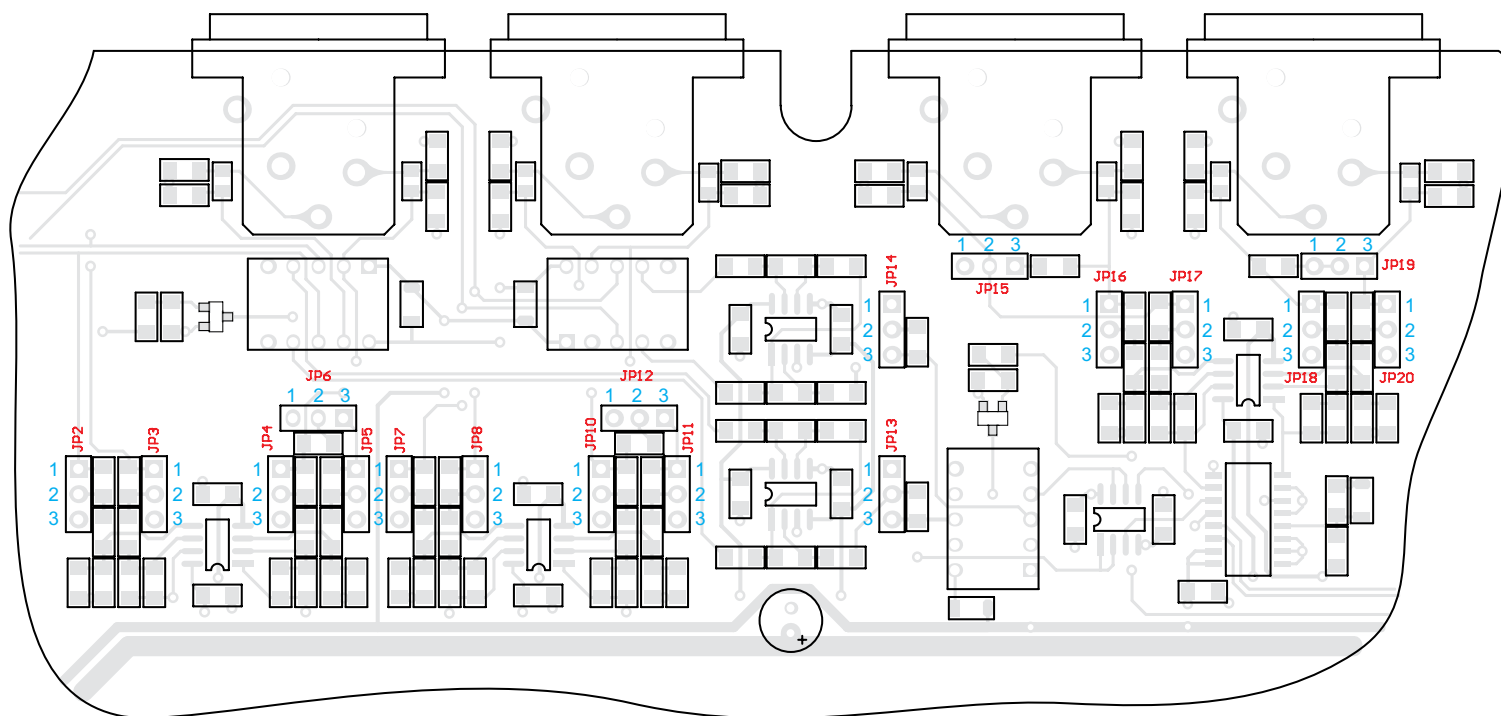

Input Impedance = 10kΩ

AUX INPUT	Channel	Jumper	Position
	LEFT	JP15	1-2
	RIGHT	JP19	1-2

## DB8000 JUMPERS LOCATION







JP6, JP12,  = 10 kΩ  
JP15, JP19  = 600 Ω

JP2, JP3, JP4, JP5,  
JP7, JP8, JP10, JP11  = 0 dB  
JP13, JP14, JP16, JP17  = -6 dB  
JP18, JP20 

## DB8000 CONFIGURATION WITH IMPEDANCE 10 kΩ AND GAIN 0 dB OF THE MAIN AND AUX INPUTS



JP6, JP12,  = 10 kΩ  
JP15, JP19  = 600 Ω

JP2, JP3, JP4, JP5,  
JP7, JP8, JP10, JP11  
JP13, JP14, JP16, JP17  
JP18, JP20  = 0 dB  = -6 dB

## DB8000 CONFIGURATION WITH IMPEDANCE 600 Ω AND GAIN -6 dB OF THE MAIN AND AUX INPUTS



JP6, JP12, = 10 kΩ  
JP15, JP19 = 600 Ω

JP2, JP3, JP4, JP5,  
JP7, JP8, JP10, JP11  
JP13, JP14, JP16, JP17  
JP18, JP20 = 0 dB = -6 dB